



**GLASSWASHER - UNDERCOUNTER
HOOD TYPE - RACK TYPE AND
FLIGHT TYPE DISHWASHERS**
洗杯机-台下式-揭盖式-通道式和长龙式洗碗机



GLOBAL EXPERTISE TOWARDS OUR LOCAL CUSTOMER 全球经验共享

our brand

Veetsan - The Dishwashing Professional.
Reliable choice and good deal wherever
professional dishwashing
is requested all over the world.

我们的品牌

威顺—专业洗碗机
全球专业洗碗机领域可靠和明智的选择

brand promise

Good value for money is what Veetsan brand
stands for and has proven in the market.
Going cross borders and being part of a
global leader in the appliance sector, we
provide "Quality & Value" for your business.
We will help you make your business
profitable, reliable and trustworthy by
supplying you professional dishwashing
competence wherever is needed.

品牌承诺

威顺品牌要成为业界投资价值的典范。
走出中国并成为全球设备生产行业的领导者，
我们将继续为合作伙伴提供“质量与价值”
并举的解决方案，
并通过在专业洗碗碟领域的竞争优势助力其事业
更具盈利性、更可靠和值得信赖。

our range



台下式洗杯机 Under-Counter Glasswasher
台下式洗杯/碗机 Under-Counter Glass and Dish washer



门式洗碗机 Door Type Dishwasher
罩式洗碗机 Hood Type Dishwasher



通道式洗碗机 Rack Conveyor Dishwasher



烘干机 Drying Tunnel



系列长龙式洗碗机 Flight Type Dishwasher

Under-Counter Glasswasher G30

台下式洗杯机 G30

特点及优势:

- 内置清洁剂分配器和催干剂分配器，且易于连接；
- 专业洗涤系统：旋转主洗臂、强动力主洗泵和大容量水箱；
- 附加冷水喷淋程序冷却可使用的啤酒杯；
- 控制面板简单易操作；
- 不锈钢双层坚固平衡门，安全塑料把手；
- 主要装置和零部件（进水电磁阀、加热包、控制面板、清洁剂分配器和催干剂分配器）便于使用、维修和保养



Characteristics and Advantages

- Detergent and rinse aid dispensers for easy connection to the external chemical source
- Washing system endowed with rotating washing arms, powerful wash pump and large wash tank for professional washing
- Extra program to cold rinse beer glasses providing sanitized cool glasses
- Simple operation control panel
- Solid double skinned counter-balance stainless steel door with hurt-free handle in plastic
- Easy service access to main components (inlet valve, boiler heating elements, control panel components, rinse aid pump and/or detergent pump) without moving the unit

技术参数 Technical Data

名称/型号	Name/Model	G30
电源要求	Power requirements	220V/50Hz/1N
外形尺寸	External dimension (mm)	700x495x456
洗涤周期	Wash cycle (s)	120
洗涤筐数	Max capacity (rack/hour)	30
最大洗涤高度	Clearance height (mm)	290
总功率	Total connected load (kW)	2.7
漂洗加热功率	Booster heater (kW)	2.5
水槽加热功率	Tank heater (kW)	2
清洗水泵功率	Wash pump (kW)	0.2
进水压力	Incoming water pressure (bar)	2 - 5
进水温度	Incoming water temperature (°C)	10 - 65
升温器容量	Booster capacity (l)	2.5
进水管径	Diameter of water inlet hose (in)	3/4
洗涤温度	Wash temperature (°C)	60
水箱容积	Wash tank capacity (l)	16
漂洗温度	Rinse temperature (°C)	82
热水喷淋循环耗水量	Hot water spray consumption (l)	2
净重	Net weight (Kg)	35
噪音	Noise (dB)	61



选装件 Optional Accessories

方形洗杯筐	Square cup washing basket	1 (400x400x110mm)
分隔器	Divider	1 (290x290x75mm)
方形刀叉筐	Square knife and fork basket	1 (89x113x113mm)

安装接驳要求 Installation and Connection Requirements

- 电力安装需要220V/50Hz/1N，外部需加装独立的空气开关
- 机器可直接与一般供水系统连接，最低水压须达到2Kg/cm²
- Power requirements: 220V/50Hz/1N + Ground with a separate external circuit breaker
- The machine can be directly connected to water supply system. The lowest incoming water pressure should be 2Kg/cm²

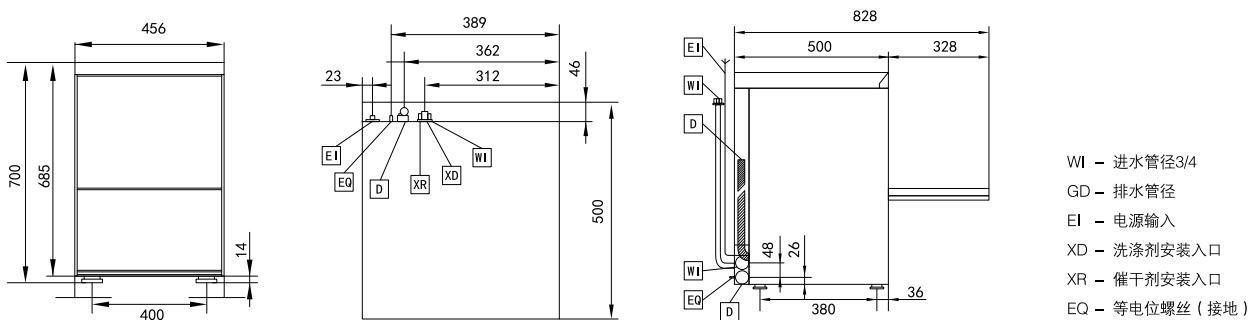

主要使用场所 Ideal for:

- 小型餐厅、咖啡厅、酒吧等场所；
- Small restaurants, coffee shops, bars and other catering industries

Under-Counter Glass and Dish washer UD-1

台下式洗杯/碗机 UD-1

特点及优势:

- 一键式按键操作，更方便；
- 自排水功能，更具人性化；
- 双层箱体，保温安全降噪；
- 深拉成型水箱，圆角设计，便于清洗；
- 排水泵更易排水；
- 高效三重过滤系统，清洗效果更佳



Characteristics and Advantages

- More convenient with one-key operation
- User-friendly design of automatic drain system
- Heat preservation and noise reduction by double-skin cabinet
- Easy to clean thanks to deep drawn tank
- Drain pump included for easy drain
- Triple filtering system: large tank filter with double-layer strainer keeps wash water clean for a longer time

可选配置 Available Configuration			
电源要求	Power Requirements	220V/50Hz/1N	380V/50Hz/3N
进水温度	Incoming water temperature (°C)	10-60	10-60
水槽加热功率	Tank heater (kW)	2	2
漂洗加热功率	Booster heater (kW)	3	4.5
清洗水泵功率	Wash pump (kW)	0.55	0.55
总功率	Total connected load (kW)	3.55	5.05
总电流	Total amps required (A)	17	9
电源线截面	Cross section of cable (mm ²)	4	2.5
空气开关额定电流	Rated current of circuit breaker (A)	25	16



选装件 Optional Accessories	
洗涤剂分配器	Detergent dispenser
快干剂分配器	Rinse aid dispenser

安装接驳要求 Installation and Connection Requirements

- 电力安装需要220V/50Hz/1N或380V/50Hz/3N，外部需加装独立的空气开关
- 机器可直接与一般供水系统连接，最低水压须达到2Kg/cm²
- Connection requirements: 220V/1N + Neutral + Ground or 380V/3N + Neutral + Ground with a separate external circuit breaker
- The machine can be directly connected to water supply system. The lowest incoming water pressure should be 2Kg/cm²

技术参数 Technical Data

名称/型号	Name/Model	UD-1
加热方式	Heating	Electricity
外形尺寸	External dimension (mm)	600x600x820
最大洗涤高度	Clearance height (mm)	310
最大洗涤量	Max capacity (rack/hour)	40
最大耗水量	Water consumption (liter/rack)	2.4
水箱容积	Wash tank capacity (l)	13
升温器容积	Booster capacity (l)	5.5
洗涤温度	Wash temperature (°C)	55 - 65
漂洗温度	Rinse temperature (°C)	65 - 88
洗涤周期	Wash cycle (s)	90/110/130
进水管径	Diameter of water inlet hose (in)	¾
排水管径	Diameter of drain pipe (in)	1¼
进水压力	Incoming water pressure (Kg/cm ²)	2 - 5
进水硬度	Incoming water hardness (g/l)	0.034 - 0.103

主要使用场所 Ideal for:

- 小型餐厅、咖啡厅、酒吧等场所；
- Small restaurants, coffee shops, bars and other catering industries

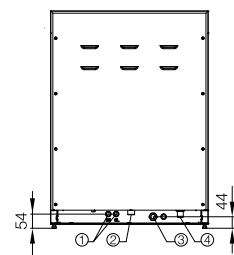
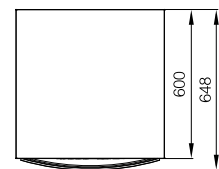
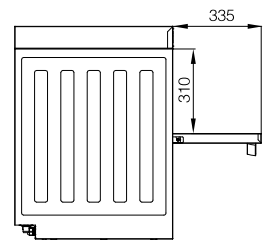
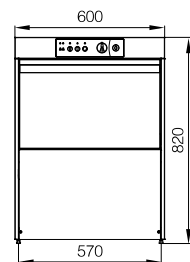

- ① 分配器连接 Dispenser Connection
- ② 进水管连接 Water Inlet Connection
- ③ 排水管连接 Drain Outlet Connection
- ④ 电源连接 Cable Connection

Door Type Dishwasher H-1

门式洗碗机 H-1

特点及优势:

- 大气式锅炉，在机器操作时无需担心进水水压和温度；
- 内置喷淋泵，防止水压波动，带来稳定的喷淋效果；
- 钻石型内部顶板，引导水和洗涤剂沿侧面滴落，保证最佳清洗效果；
- 全不锈钢结构，使用寿命更长；
- 电脑版控制面板，操作方便、准确；
- 可拆卸式内部配件，清洗更容易；



Characteristics and Advantages

- Worry-free operation independently from inlet water pressure and temperature thanks to atmospheric boiler
- Built-in rinse pump prevents water pressure fluctuation and stabilizes rinse water temperature for steady rinse effect
- Optimal rinsing performance guaranteed by diamond-shaped ceiling that guides water with detergent to drip along the side panels during rinsing phase
- Long lasting operation thanks to all stainless steel construction
- User-friendly electronic control panel
- Easy to clean with all internal components readily removable

可选配置	Available Configuration		
电源要求	Power Requirements	380V/50Hz/3N	380V/50Hz/3N
进水温度	Incoming water temperature (°C)	10-60	40-60
水槽加热功率	Tank heater (kW)	3	3
漂洗加热功率	Booster heater (kW)	7x2	7
清洗水泵功率	Wash pump (kW)	0.735	0.735
漂洗水泵功率	Rinse pump (kW)	0.23	0.23
总功率	Total connected load (kW)	18	11
总电流	Total amps required (A)	28	17
电源线截面	Cross section of cable (mm ²)	6	4
空气开关额定电流	Rated current of circuit breaker (A)	40	25



安装接驳要求 Installation and Connection Requirements

- 电力安装需要380V/50Hz/3N，外部需加装独立的空气开关
- 洗涤流程中需要另配排风罩、污碟台、洁碟台、花洒龙头、杯筐、药液分配器、机用清洁剂和催干剂等
- 机器可直接与一般供水系统连接，最低水压须达到0.3Kg/cm²
- 如需安装排气罩，其排气量至少应为2.8 m³/min
- Power requirements: 380V/50Hz/3N + Neutral + Ground, with a separate external circuit breaker
- In the washing process, additional exhaust hood, working tables, baskets, liquid medicine dispensers, machine used detergent and rinse aid are needed to be equipped
- The machine can be directly connected with water supply system. The lowest incoming water pressure should be 0.3Kg/cm²
- If a hood or vent needed, the minimum capacity should be 2.8 m³/min

技术参数 Technical Data

名称/型号	Name/Model	H-1
加热方式	Heating	Electricity
外形尺寸	External dimension (mm)	696x712x1440
最大洗涤高度	Clearance height (mm)	420
最大洗涤量	Max capacity (rack/hour)	60
最大耗水量	Water consumption (liter/rack)	2.5
水箱容积	Wash tank capacity (l)	32
升温器容积	Booster capacity (l)	14
洗涤温度	Wash temperature (°C)	60 - 65
漂洗温度	Rinse temperature (°C)	82 - 90
洗涤周期	Wash cycle (s)	60/90/120
进水管径	Diameter of water inlet hose (in)	¾
排水管径	Diameter of drain pipe (in)	1 ¼
进水压力	Incoming water pressure (Kg/cm ²)	0.3 - 5
进水硬度	Incoming water hardness (g/l)	0.034 - 0.103

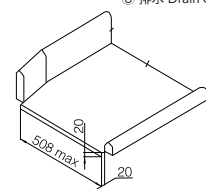
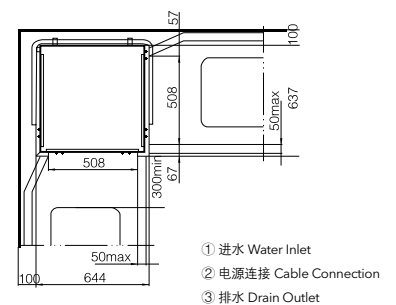
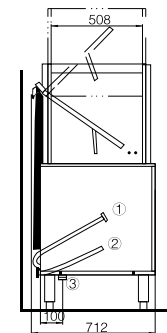
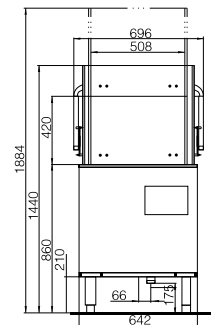

主要使用场所 Ideal for:

- 中、小型饭店、咖啡厅、连锁餐厅和食堂
- Medium and small hotels, coffee shops, chain restaurants and dining halls

Hood Type Dishwasher H-2

罩式洗碗机 H-2

特点及优势:

- 大气式锅炉，在机器操作时无需担心进水水压和温度；
- 内置喷淋泵，防止水压波动，带来稳定的喷淋效果；
- 钻石型内部顶板，引导水和洗涤剂沿侧面滴落，保证最佳清洗效果；
- 全不锈钢结构，使用寿命更长；
- 可拆卸式内部配件，清洗更容易；



Characteristics and Advantages

- Worry-free operation independently from inlet water pressure and temperature thanks to atmospheric boiler
- Built-in rinse pump prevents water pressure fluctuation and stabilizes rinse water temperature for steady rinse effect
- Optimal rinsing performance guaranteed by diamond-shaped ceiling that guides water with detergent to drip along the side panels during rinsing phase
- Long lasting operation thanks to all stainless steel construction
- Easy to clean with all internal components readily removable

可选配置	Available Configuration		
电源要求	Power Requirements	380V/50Hz/3N	380V/50Hz/3N
进水温度	Incoming water temperature (°C)	10-60	40-60
水槽加热功率	Tank heater (kW)	3	3
漂洗加热功率	Booster heater (kW)	7x2	7
清洗水泵功率	Wash pump (kW)	0.735	0.735
漂洗水泵功率	Rinse pump (kW)	0.23	0.23
总功率	Total connected load (kW)	18	11
总电流	Total amps required (A)	28	17
电源线截面	Cross section of cable (mm ²)	6	4
空气开关额定电流	Rated current of circuit breaker (A)	40	25



安装接驳要求 Installation and Connection Requirements

- 电力安装需要380V/50Hz/3N，外部需加装独立的空气开关
- 洗涤流程中需要另配排风罩、污碟台、洁碟台、花洒龙头、杯筐、药液分配器、机用清洁剂和催干剂等
- 机器可直接与一般供水系统连接，最低水压须达到0.3Kg/cm²
- 如需安装排气罩，其排气量至少应为2.8 m³/min
- Power requirements: 380V/50Hz/3N + Neutral + Ground, with a separate external circuit breaker
- In the washing process, additional exhaust hood, working tables, baskets, liquid medicine dispensers, machine used detergent and rinse aid are needed to be equipped
- The machine can be directly connected with water supply system. The lowest incoming water pressure should be 0.3Kg/cm²
- If a hood or vent needed, the minimum capacity should be 2.8 m³/min

技术参数 Technical Data

名称/型号	Name/Model	H-2
加热方式	Heating	Electricity
外形尺寸	External dimension (mm)	756x835x1508
最大洗涤高度	Clearance height (mm)	420
最大洗涤量	Max capacity (rack/hour)	60
最大耗水量	Water consumption (liter/rack)	2.5
水箱容量	Wash tank capacity (l)	32
升温器容积	Booster capacity (l)	14
洗涤温度	Wash temperature (°C)	60 - 65
漂洗温度	Rinse temperature (°C)	82 - 90
洗涤周期	Wash cycle (s)	60/90/120
进水管径	Diameter of water inlet hose (in)	¾
排水管径	Diameter of drain pipe (in)	1 ¼
进水压力	Incoming water pressure (Kg/cm ²)	0.3 - 5
进水硬度	Incoming water hardness (g/l)	0.034 - 0.103

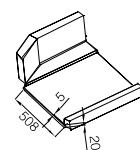
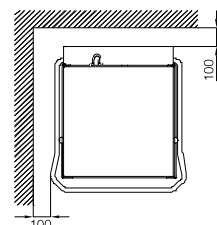
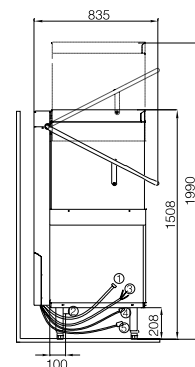
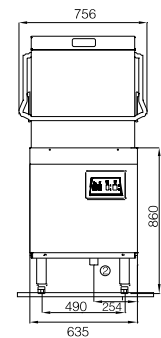

- ① 进水管 Water Inlet
- ② 排水 Drain Outlet
- ③ 电源连接 Cable Connection
- ④ 清洁剂(可选) Detergent In (Optional)
- ⑤ 催干剂(可选) Rinse Aid In (Optional)

主要使用场所 Ideal for:

- 中、小型饭店、咖啡厅、连锁餐厅、食堂
- Medium and small hotels, coffee shops, chain restaurants and dining halls

Rack Conveyor Dishwasher R-1E/R-1S

通道式洗碗机 R-1E/R-1S

特点及优势:

- 每小时最大洗涤量为200筐;
- 所有部件(水箱、加热包、清洗臂和漂洗臂)等都采用304不锈钢材质,保证长时间的运行质量;
- 所有配件都易于拆卸和清洗;
- 自动启动/停止,进一步降低机器运行成本;
- 一体式上罩设计,防止水溅出并可在安装过程中更改机器运行方向;
- 多种适用范围,热水和冷水均可使用。



Characteristics and Advantages

- High capacity per hour: 200 racks
- Long lasting operation as all components including tank, boiler, wash and rinse arms are made of stainless steel 304
- All internal components are easy to remove and clean
- Auto start/stop levers further reduce water and energy consumption
- Integrated splash hood avoids splash and makes it easy to switch direction during installation
- Various range suitable to both hot and cold main water supply temperature

可选配置	Available Configuration			
加热方式	Heating	Electricity	Electricity	Steam
电源要求	Requirements	380V/50Hz/3N	380V/50Hz/3N	380V/50Hz/3N
进水温度	Incoming water temperature (°C)	10-60	40-60	10-60
水槽加热功率	Tank heater (kW)	7.5	7.5	-
漂洗加热功率	Booster heater (kW)	18x2	18	-
蒸汽总耗量	Total Steam Consumption (Kg/h)	-	-	75
清洗水泵功率	Wash pump (kW)	1.5	1.5	1.5
传动马达功率	Drive motor (kW)	0.2	0.2	0.2
总功率	Total connected load (kW)	46	28	2.5
总电流	Total amps required (A)	70	43	4
电源线截面	Cross section of cable (mm ²)	25	10	2.5
空气开关额定电流	Rated current of circuit breaker (A)	100	63	16



安装接驳要求 Installation and Connection Requirements

- 电力安装需要380V/50Hz/3^N，外部需加装独立的空气开关
- 洗涤流程中需要另配排风罩、污碟台、洁碟台、花洒龙头、杯筐、药液分配器、机用清洁剂和催干剂等
- 机器可直接与一般供水系统连接，最低水压须达到2Kg/cm²
- 如需安装排气罩，排气量为入口端—5.7 m³/min，出口端—2.8 m³/min
- Connection requirements: 380V/3N + Neutral + Ground, with an external circuit breaker
- In the washing process, additional exhaust hood, working tables, baskets, chemical dispensers, detergent and rinse aid need to be equipped
- The machine can be directly connected to water supply. The lowest incoming water pressure should be 2Kg/cm²
- If a hood or vent is needed, the inlet capacity should be 5.7m³/min and the outlet 11.3m³/min

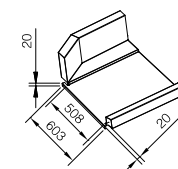
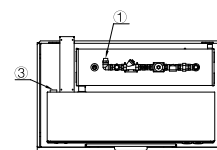
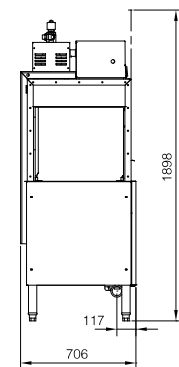
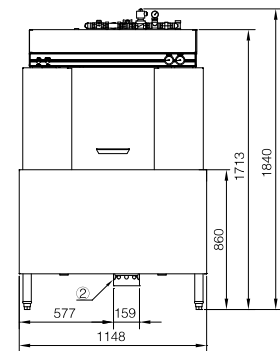

- ① 进水口 Water In
- ② 排水口 Drain Out
- ③ 电源连接 Cable Connection

技术参数 Technical Data

名称/型号	Name/Model	R-1E/R-1S
加热方式	Heating	Electricity/Steam
机器尺寸	External dimension (mm)	1148x706x1840
最大洗涤高度	Clearance height (mm)	450
最大洗涤量	Max capacity (rack/hour)	200
最大耗水量	Water consumption (liter/rack)	2
水箱容积	Wash tank capacity (l)	90
升温器容积	Booster capacity (l)	20.8
洗涤温度	Wash temperature (°C)	60 - 65
漂洗温度	Rinse temperature (°C)	82 - 90
进水管径	Diameter of water inlet hose (in)	¾
排水管径	Diameter of drain pipe (in)	2
进水压力	Incoming water pressure (Kg/cm ²)	2 - 5
进水硬度	Incoming water hardness (g/l)	0.034 - 0.103

主要使用场所 Ideal for:

- 中型酒店、宾馆、连锁餐厅、食堂
- Medium hotels, guest houses, chain restaurants and dining halls

Rack Conveyor Dishwasher R-1ER/R-1SR

通道式洗碗机 R-1ER/R-1SR

特点及优势:

- 每小时最大洗涤量为220筐;
- 双喷淋系统, 取得更好喷淋效果的同时, 实现将近40%的成本节省;
- 所有部件(水箱、加热包、清洗臂和漂洗臂)等都采用304不锈钢材质, 保证长时间的运行质量;
- 所有配件都易于拆卸和清洗;
- 自动启动/停止, 进一步降低机器运行成本;
- 一体式上罩设计, 防止水溅出并可在安装过程中更改机器运行方向;
- 多种适用范围, 热水和冷水均可使用。



Characteristics and Advantages

- High capacity per hour: 220 racks
- Duo rinse system guarantees thorough rinsing performance and saves running cost by 40%
- Long lasting operation as all components including tank, boiler, wash and rinse arms are made of stainless steel 304
- All internal components are easy to remove and clean
- Auto start/stop levers further reduce water and energy consumption
- Integrated splash hood avoids splash and makes it easy to switch direction during installation
- Various range suitable to both hot and cold main water supply temperature

可选配置	Available Configuration			
加热方式	Heating	Electricity	Electricity	Steam
电源要求	Power Requirements	380V/50Hz/3N	380V/50Hz/3N	380V/50Hz/3N
进水温度	Incoming water temperature (°C)	10-60	40-60	10-60
水槽加热功率	Tank heater (kW)	7.5	7.5	-
漂洗加热功率	Booster heater (kW)	9x4	9x2	-
蒸汽总耗量	Total Steam Consumption (Kg/h)	-	-	75
清洗水泵功率	Wash pump (kW)	1.5	1.5	1.5
漂洗水泵功率	Rinse pump (kW)	0.25	0.25	0.25
传动马达功率	Drive motor (kW)	0.2	0.2	0.2
总功率	Total connected load (kW)	46	28	3
总电流	Total amps required (A)	70	43	5
电源线截面	Cross section of cable (mm ²)	25	10	2.5
空气开关额定电流	Rated current of circuit breaker (A)	100	63	16



安装接驳要求 Installation and Connection Requirements

- 电力安装需要380V/50Hz/3N，外部需加装独立的空气开关
- 洗涤流程中需要另配排风罩、污碟台、洁碟台、花洒龙头、杯筐、药液分配器、机用清洁剂和催干剂等
- 机器可直接与一般供水系统连接，最低水压须达到2Kg/cm²
- 如需安装排气罩，排气量为入口端—5.7 m³/min，出口端—11.3m³/min
- Connection requirements: 380V/3N + Neutral + Ground, with an external circuit breaker
- In the washing process, additional exhaust hood, working tables, baskets, chemical dispensers, detergent and rinse aid need to be equipped
- The machine can be directly connected to water supply. The lowest incoming water pressure should be 2Kg/cm²
- If a hood or vent is needed, the inlet capacity should be 5.7m³/min and the outlet 11.3m³/min

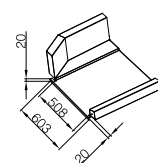
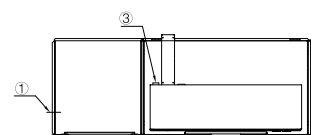
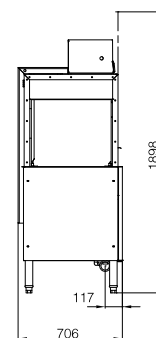
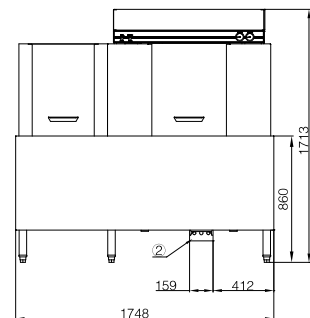

技术参数 Technical Data

名称/型号	Name/Model	R-1ER/R-1SR
加热方式	Heating	Electricity/Steam
外形尺寸	External dimension (mm)	1748x706x1713
最大洗涤高度	Clearance height (mm)	450
最大洗涤量	Max capacity (rack/hour)	220
最大耗水量	Water consumption (liter/rack)	1.2
水箱容积	Wash tank capacity (l)	90
升温器容积	Booster capacity (l)	25
洗涤温度	Wash temperature (°C)	60 - 65
漂洗温度	Rinse temperature (°C)	82 - 90
进水管径	Diameter of water inlet hose (in)	¾
排水管径	Diameter of drain pipe (in)	2
进水压力	Incoming water pressure (Kg/cm ²)	2 - 5
进水硬度	Incoming water hardness (g/l)	0.034 - 0.103

主要使用场所 Ideal for:

- 中型酒店、宾馆、连锁餐厅、食堂
- Medium hotels, guest houses, chain restaurants and dining halls

- ① 进水口 Water In
- ② 排水口 Drain Out
- ③ 电源连接 Cable Connection

Rack Conveyor Dishwasher R-2E/R-2S

通道式洗碗机 R-2E/R-2S

特点及优势:

- 每小时最大洗涤量为250筐;
- 所有部件(水箱、加热包、清洗臂和漂洗臂)等都采用304不锈钢材质,保证长时间的运行质量;
- 所有配件都易于拆卸和清洗;
- 自动启动/停止,进一步的减轻机器运行成本;
- 一体式上罩设计,防止水溅出;
- 多种适用范围,热水和冷水均可使用。



Characteristics and Advantages

- High capacity per hour: 250 racks
- Long lasting operation as all components including tank, boiler, wash and rinse arms are made of stainless steel 304
- All internal components are easy to remove and clean
- Auto start/stop levers further reduce water and energy consumption
- Integrated splash hood avoids splash
- Various range suitable to both hot and cold main water supply temperature

可选配置	Available Configuration			
加热方式	Heating	Electricity	Electricity	Steam
电源要求	Power Requirements	380V/50Hz/3N	380V/50Hz/3N	380V/50Hz/3N
进水温度	Incoming water temperature (°C)	10-60	40-60	10-60
水槽加热功率	Tank heater (kW)	7.5x2	7.5x2	-
漂洗加热功率	Booster heater (kW)	18x2	18	-
蒸汽总耗量	Total Steam Consumption (kg/h)	-	-	88
清洗水泵功率	Wash pump (kW)	1.5x2	1.5x2	1.5x2
传动马达功率	Drive motor (kW)	0.2	0.2	0.2
总功率	Total connected load (kW)	55	37	4
总电流	Total amps required (A)	84	57	6
电源线截面	Cross section of cable (mm ²)	25	16	2.5
空气开关额定电流	Rated current of circuit breaker (A)	100	80	16



安装接驳要求 Installation and Connection Requirements

- 电力安装需要380V/50Hz/3N，外部需加装独立的空气开关
- 洗涤流程中需要另配排风罩、污碟台、洁碟台、花洒龙头、杯筐、药液分配器、机用清洁剂和催干剂等
- 机器可直接与一般供水系统连接，最低水压须达到2Kg/cm²
- 如需安装排气罩，排气量为入口端-5.7 m³/min，出口端-11.3m³/min
- Connection requirements: 380V/3N + Neutral + Ground, with an external circuit breaker
- In the washing process, additional exhaust hood, working tables, baskets, chemical dispensers, detergent and rinse aid need to be equipped
- Machine can be directly connected to water supply. The lowest incoming water pressure should be 2kg/cm²
- If a hood or vent is needed, the inlet capacity should be 5.7m³/min and the outlet 11.3m³/min

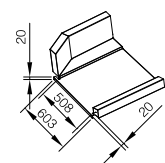
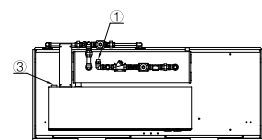
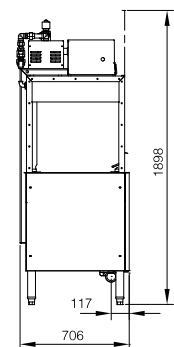
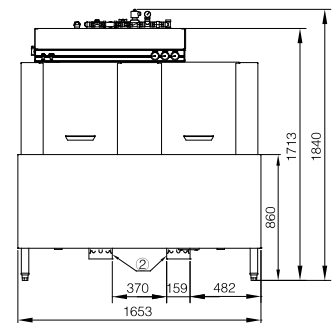

技术参数 Technical Data

名称/型号	Name/Model	R-2E/R-2S
加热方式	Heating	Electricity/Steam
外形尺寸	External dimension (mm)	1653x706x1840
最大洗涤高度	Clearance height (mm)	450
最大洗涤量	Max capacity (rack/hour)	250
最大耗水量	Water consumption (liter/rack)	1.5
水箱容积	Wash tank capacity (l)	90x2
升温器容积	Booster capacity (l)	20.8
洗涤温度	Wash temperature (°C)	60 - 65
漂洗温度	Rinse temperature (°C)	82 - 90
进水管径	Diameter of water inlet hose (in)	¾
排水管径	Diameter of drain pipe (in)	2
进水压力	Incoming water pressure (Kg/cm ²)	2 - 5
进水硬度	Incoming water hardness (g/l)	0.034 - 0.103

主要使用场所 Ideal for:

- 中、大型酒店、宾馆、连锁餐厅、食堂
- Medium and large hotels, guest houses, chain restaurants and dining halls

- ① 进水口 Water In
- ② 排水口 Drain Out
- ③ 电源连接 Cable Connection

Rack Conveyor Dishwasher R-2ER/R-2SR

通道式洗碗机 R-2ER/R-2SR

特点及优势:

- 最大洗涤量为280筐/小时;
- 双喷淋系统, 取得更好喷淋效果的同时, 实现将近40%的成本节省;
- 所有配件(水箱、加热包、清洗臂和漂洗臂)等都采用304不锈钢材质, 保证长时间的运行质量;
- 所有配件都易于拆卸和清洗;
- 自动启动/停止, 进一步的降低机器运行成本;
- 一体式上罩设计, 防止水溅出;
- 多种适用范围, 热水和冷水均可使用。



Characteristics and Advantages

- High capacity per hour: 280 racks
- Duo rinse system guarantees thorough rinsing performance and saves running cost by 40%
- Long lasting operation as all components including tank, boiler, wash and rinse arms are made of stainless steel 304
- All internal components are easy to remove and clean
- Auto start/stop levers further reduce water and energy consumption
- Integrated splash hood avoids splash
- Various range suitable to both hot and cold main water supply temperature

可选配置	Available Configuration			
加热方式	Heating	Electricity	Electricity	Steam
电源要求	Power Requirements	380V/50Hz/3N	380V/50Hz/3N	380V/50Hz/3N
进水温度	Incoming water temperature (°C)	10-60	40-60	10-60
水槽加热功率	Tank heater (kW)	7.5x2	7.5x2	-
漂洗加热功率	Booster heater (kW)	9x4	9x2	-
蒸汽总耗量	Total Steam Consumption (kg/h)	-	-	88
清洗水泵功率	Wash pump (kW)	1.5x2	1.5x2	1.5x2
漂洗水泵功率	Rinse pump (kW)	0.25	0.25	0.25
传动马达功率	Drive motor (kW)	0.2	0.2	0.2
总功率	Total connected load (kW)	55	37	4.5
总电流	Total amps required (A)	84	57	7
电源线截面	Cross section of cable (mm ²)	25	16	2.5
空气开关额定电流	Rated current of circuit breaker (A)	100	80	16



安装接驳要求 Installation and Connection Requirements

- 电力安装需要380V/50Hz/3N，外部需加装独立的空气开关
- 洗涤流程中需要另配排风罩、污碟台、洁碟台、花洒龙头、杯筐、药液分配器、机用清洁剂和催干剂等
- 机器可直接与一般供水系统连接，最低水压须达到2Kg/cm²
- 如需安装排气罩，排气量为入口端—5.7 m³/min，出口端—11.3m³/min
- Connection requirements: 380V/3N + Neutral + Ground, with an external circuit breaker
- In the washing process, additional exhaust hood, working tables, baskets, chemical dispensers, detergent and rinse aid need to be equipped
- Machine can be directly connected to water supply. The lowest incoming water pressure should be 2kg/cm²
- If a hood or vent is needed, the inlet capacity should be 5.7m³/min and the outlet 11.3m³/min

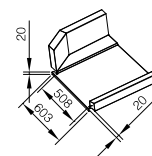
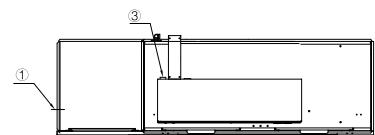
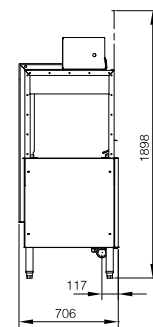
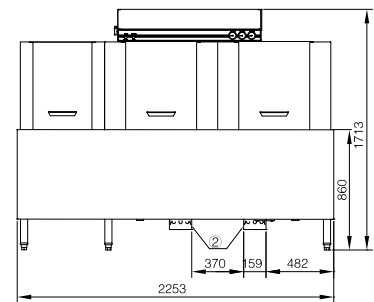

技术参数 Technical Data

名称/型号	Name/Model	R-2ER/R-2SR
加热方式	Heating	Electricity/Steam
外形尺寸	External dimension (mm)	2253x706x1713
最大洗涤高度	Clearance height (mm)	450
最大洗涤量	Max capacity (rack/hour)	280
最大耗水量	Water consumption (liter/rack)	1
水箱容积	Wash tank capacity (l)	90x2
升温器容积	Booster capacity (l)	25
洗涤温度	Wash temperature (°C)	60 - 65
漂洗温度	Rinse temperature (°C)	82 - 90
进水管径	Diameter of water inlet hose (in)	¾
排水管径	Diameter of drain pipe (in)	2
进水压力	Incoming water pressure (bar)	2 - 5
进水硬度	Incoming water hardness (g/l)	0.034 - 0.103

主要使用场所 Ideal for:

- 中、大型酒店、宾馆、连锁餐厅、食堂
- Medium and large hotels, guest houses, chain restaurants and dining halls

- ① 进水口 Water In
- ② 排水口 Drain Out
- ③ 电源连接 Cable Connection

Drying Tunnel DE/DS

烘干机 DE/DS

餐具所选材料的种类很多，与陶瓷餐具相比，不锈钢和密胺等餐具不易保存热量，导致餐具干燥时间过长，影响餐具的卫生效果。因此加装烘干机是保障餐具消毒以及加快餐具周转的最佳选择。

Among the various tableware of different materials, stainless steel and melamine wares don't keep heat well compared to glass and ceramic ones, resulting in long drying time and unsatisfactory hygiene. Therefore, drying tunnel is the best choice to guarantee disinfection and speed up turnover of tableware.





特点和优势 Characteristic and Advantages

- 强制循环的高速热空气完全包围餐具，促使餐具快速干燥；
- 高效9kW加热管及0.55kW风机
- 电及蒸汽加热可供选择
- Tableware completely surrounded by forced circulation of high-speed hot air for rapid drying
- With 9kW efficient heater and 0.55kW fans
- Electricity and steam heating options

技术参数 Technical Data

名称/型号	Name/Model	DE	DS
加热方式	Heating	Electricity	Steam
外形尺寸	External dimension (mm)	900x713x2160	900x713x2160
最大烘干高度	Maximum height of drying (mm)	450	450
烘干加热功率	Drying heater (kW)	9	-
蒸汽总耗量	Total steam consumption (kg/h)	-	15
风机功率	Fan Power (kW)	0.55	0.55
热风循环量	Volume of hot air circulation (m ³ /h)	2900	2900
总功率	Total connected load (kW)	10	0.55

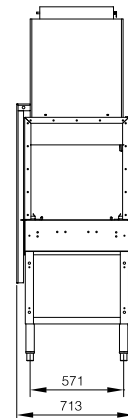
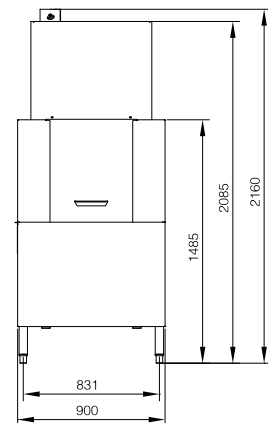

主要使用场所 Ideal for:

- 中、大型酒店、宾馆、连锁餐厅和食堂
- Medium and large hotels, guest houses, chain restaurants and dining halls

Flight Type Dishwasher FEA-series

FEA 系列长龙式洗碗机

特点及优势:

- 高效的烘干机及风刀配置，保证洗涤效果；
- 独特的环绕喷淋设计，使水幕分布更加均匀，保证洗涤效果的同时，实现了20%的能耗节约；
- 机械式按钮设计，操作简单方便；
- 灵活的模块组合设计，可根据现场的空间尺寸来选择合适的型号；
- 可靠的履带式传送系统配有自动过载保护装置，碗碟、餐盘可直接放于履带上，无需分装装筐和将筐推进洗碗机，大大降低了劳动强度，同时减少了工作时间；
- 门有双重保护，内置卷簧及门挂钩，保证操作者安全；
- 基于人体工程学的操作高度，使操作人员轻松装卸餐具，降低劳动强度；
- 出入口配备启动/停止/紧急开关装置，方便操作人员控制机器的运行；
- 出口端装有限位开关，防止餐具因未及时卸载而造成破损。



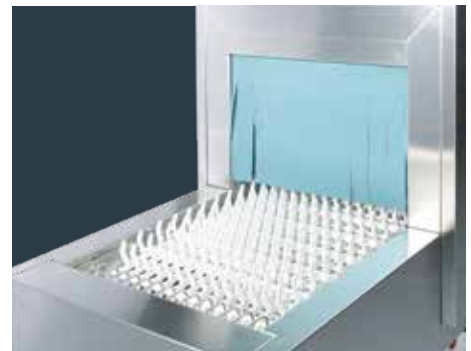

Characteristics and Advantages

- Efficient dryer and air knives ensure drying efficient
- Unique design of rotating wash and rinse system spays water more even to ensure cleaning result and save energy by 20%
- Mechanical button design easy to operate
- With flexible modular design you can choose suitable model according to the size on site
- Reliable conveyor system with automatic overload protection device so that dishes and plates can be directly put on the track, thus no need to sort wares and put them in the baskets, greatly reducing labor intensity and working time
- Double-skin door, built-in spring and door hook to protect ensure the safety of the operator
- Built at ergonomic height, easy for operator to remove the tableware
- EMERGENCY STOP devices are equipped at the entrance & exit, convenient for operation
- Exit end is equipped with limit switch to avoid damages on the wares when nobody takes them off the conveyor

Flight Type Dishwasher FEA-series

FEA 系列长龙式洗碗机

安装要求 Available Configuration

电源要求	Power Requirements	380V/50Hz/3N
进水管径	Diameter of water inlet pipe (in)	¾
排水管径	Diameter of drain pipe (in)	2
进水压力	Incoming water pressure (Kg/cm ²)	2 - 5
进水温度	Incoming water temperature (°C)	10 - 60
进水硬度	Incoming water hardness (g/l)	0.034 - 0.103

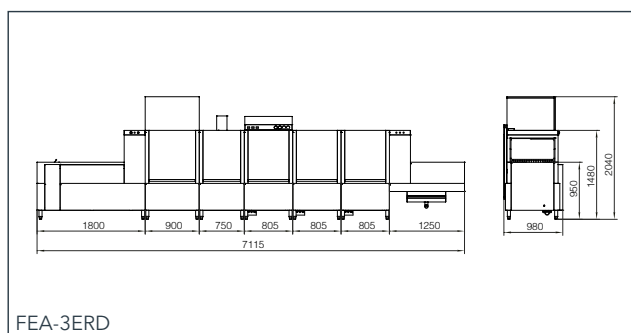
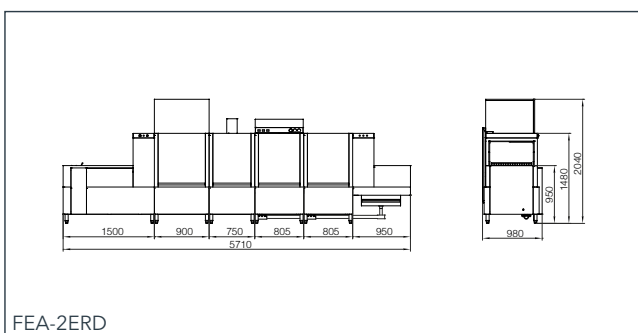
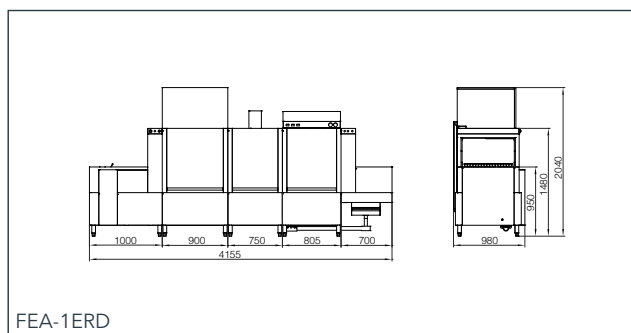
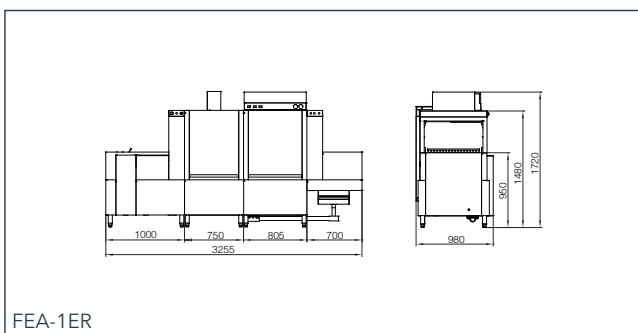

型号 Model	加热方式 Heating	外形尺寸 Dimension (mm)	洗涤能力 Max capacity (dish/hour)	总功率 Total connected load (kW)	最大耗水量 Max water consumption (liter/hour)
FEA-1ER/FEA-1SR	电/蒸汽 Electric/Steam	3255×980×1720	3400 ~ 6800	54/3	280
FEA-1ERD/FEA-1SRD	电/蒸汽 Electric/Steam	4155×980×2040	3400 ~ 6800	67/4	280
FEA-2ER/FEA-2SR	电/蒸汽 Electric/Steam	4810×980×1720	4800 ~ 9600	71/5	280
FEA-2ER-P/FEA-2SR-P	电/蒸汽 Electric/Steam	4810×980×1720	4800 ~ 9600	56/5	280
FEA-2ERD/FEA-2SRD	电/蒸汽 Electric/Steam	5710×980×2040	4800 ~ 9600	84/6	280
FEA-2ERD-P/FEA-2SRD-P	电/蒸汽 Electric/Steam	5710×980×2040	4800 ~ 9600	69/6	280
FEA-3ER/FEA-3SR	电/蒸汽 Electric/Steam	6215×980×1720	6500 ~ 13000	89/7.2	280
FEA-3ER-P/FEA-3SR-P	电/蒸汽 Electric/Steam	6215×980×1720	6500 ~ 13000	74/7.2	280
FEA-3ERD/FEA-3SRD	电/蒸汽 Electric/Steam	7115×980×2040	6500 ~ 13000	102/8	280
FEA-3ERD-P/FEA-3SRD-P	电/蒸汽 Electric/Steam	7115×980×2040	6500 ~ 13000	87/8	280

安装接驳要求 Installation and Connection Requirements

- 电力安装需要380V/50Hz/3N，外部需加装独立的空气开关
- 机器可直接与一般供水系统连接，最低水压须达到2Kg/cm²
- Power requirements: 380V/50Hz/3N + Neutral + Ground, with an external circuit breaker
- The machine can be directly connected with water supply system, the lowest incoming water pressure should be 2kg/cm²

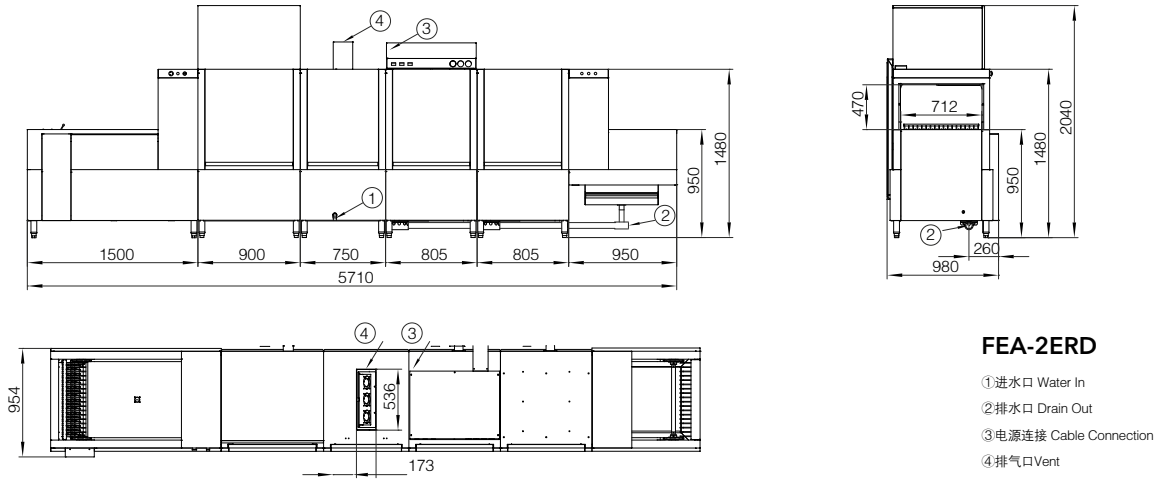

FEA-2ERD

- ① 进水口 Water In
- ② 排水口 Drain Out
- ③ 电源连接 Cable Connection
- ④ 排气口 Vent

机器配置 (Model configuration)

- 主洗-可选 (Wash-Optional)
- 加热方式-可选 (Heating mode-Optional)
- 喷淋-可选 (Rinse Optional)
- 风刀-模块可选 (Air knife-Optional Modular)
- 烘干-模块可选 (Drying-Optional Modular)
- 热回收-模块可选 (Heat recovery-Optional Modular)

- 1-单缸(Single Tank)
- 2-双缸(Double Tank)
- 3-三缸(Triple Tank)
- E-电加热(Electrical heating)
- S-蒸汽加热(Steam heating)
- R-双喷淋(Double rinse)
- 缺省(Default) - 单喷淋(Single rinse)
- B-单风刀(Single air knife)
- 2B-双风刀(Double air knife)
- D-单烘干(Single drying)
- 2D-双烘干(Double drying)
- H-单热回收(Heat recovery)

机型示例 (Demonstration)

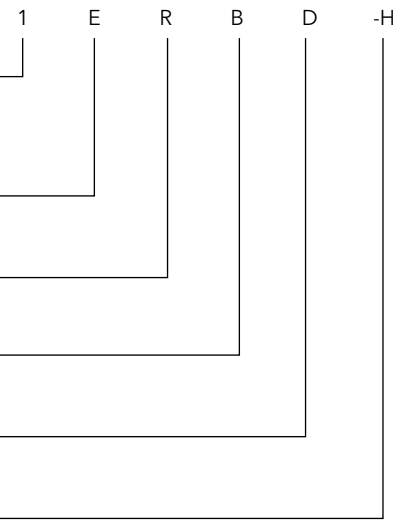

水槽加热功率 Tank Heater (kW)	漂洗加热功率 Booster Heater (kW)	烘干机功率 Power of drying tunnel (kW)	水泵加传动电机 Pump+Conveyor motor (kW)	蒸汽总耗量 Total steam consumption (Kg)	电源线截面 Cross section of cable (mm ²)	空气开关额定电流 Rated current of circuit breaker (A)
15	36	--	2.8	90	25	100/20
15	36	13	2.8	110	35	125/20
15×2	36	--	5	116	35	125/25
15	36	--	5	90	25	100/25
15×2	36	13	5	137	50	150/25
15	36	13	5	110	35	125/25
15×3	36	--	7.2	142	50	200/40
15×2	36	--	7.2	116	35	150/40
15×3	36	13	7.2	163	50	200/40
15×2	36	13	7.2	137	50	200/40



公司简介

上海威顺公司成立于2003年，是国内最早进入商用洗碗机领域的企业之一。

公司总部位于中国上海，占地35亩，厂房面积约2.7万平方米。公司拥有数控激光切割机、数控转塔式冲床、数控折弯机、数控剪板机等自动化设备，现已形成年产10000台洗碗机的生产规模，拥有员工200余人，在全国设有20多个办事处，具备覆盖全国的销售和服务网络。

威顺公司一直以来致力于以颇具竞争力的价格，向全球客户提供相当于国际水准的全系列商用洗碗机产品、优质高效的服务及餐具卫生解决方案。公司每年在产品研发、服务提升、人员培训、渠道建设上的不断投入，保证了威顺的每一位客户以最小的成本享受到最大的价值。

经过十多年的发展，公司产品覆盖全国各地，相继进入欧洲、南美洲、澳洲、亚洲、非洲等地区，合作伙伴遍及全球。高性价比的产品成为了行业内广大客户的首选，威顺是您餐具洗涤领域的最好合作伙伴。

展望未来，威顺公司将不断开拓创新，肩负强烈的社会责任感，致力于发展成为中国最大、最专业的商用洗碗机制造商。



VEETSAN

the dishwashing **PROFESSIONAL**

COMPANY PROFILE

Veetsan Electrical Appliance Co., Ltd. was founded in 2003 and entered the field of commercial ware washing the earliest in China.

Located in Shanghai, Veetsan has plant area of more than 20,000 square meter. We have complete production equipments including NC laser cutting machine, NC turret punch and NC bending machine. We have also employees of more than 200 people with productivity of more than 10,000 sets of dishwashers per year and 20 sales and service offices all around China.

With the company core values of honesty, teamwork, quality, continuous learning and customer orientation, Veetsan sold dishwashers in all markets in China, built the largest after sales network and exported to most of the markets around the world. We have business partners in Latin America, Europe, Asia and Oceania. Thanks to our diligent working attitude, professional operation and constant pursuit of quality, Veetsan has become a rapidly developing and prestigious company, leading the field of commercial dishwasher in China in terms of R&D, production and sales.

Veetsan supplies all range of dishwashers of high quality and reliable performance for star hotels, chain restaurants, large companies and schools. Veetsan products will be your first choice, and Veetsan will be your best partner in the field of ware washing.

In the future, with the strong sense of social responsibility, Veetsan will be committed to become the largest and most professional manufacturer of commercial dishwasher in China.

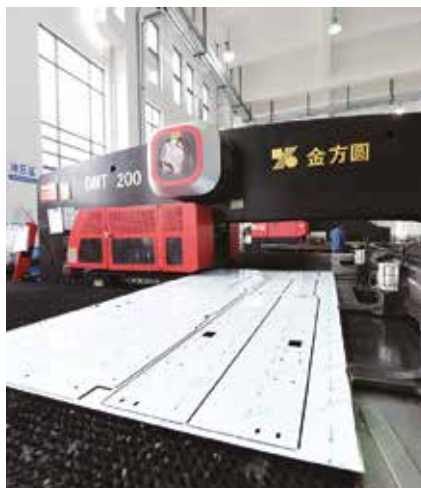



the dishwashing
PROFESSIONAL

www.veetsan.com.cn